



ROTECH FOR RELIABILITY!

*Why Accept Anything Less?*

## AE 3000 Series Aluminium Body Extra Heavy Duty – End of Shaft

The AE 3000 series of Rotech shaft mounted sensors & encoders are manufactured in an extremely tough and durable aluminium casting with an industrial powder coated hammer blue finish. Designed for areas subject to extreme operating conditions, constant water spray, high pressure washing, severe dust or material contamination. This unit also has the added benefit of a rechargeable grease chamber that can be reloaded via the recharge nipple. Installation is simple and easy, just one 12mm threaded hole in the end of the shaft being monitored or fitted using the unique "Mag-con" magnetic connector for speeds below 300 RPM (see below). A wide range of number of pulses per revolution are available together with AC and DC electrical outputs.

Recharge Nipple

SPRING LOADED SHAFT SEAL  
+  
RE-CHARGEABLE GREASE CHAMBER  
+  
SPRING LOADED SHAFT SEAL  
+  
SEALS PROTECTOR  
=  
**IP67**  
TOTAL PROTECTION

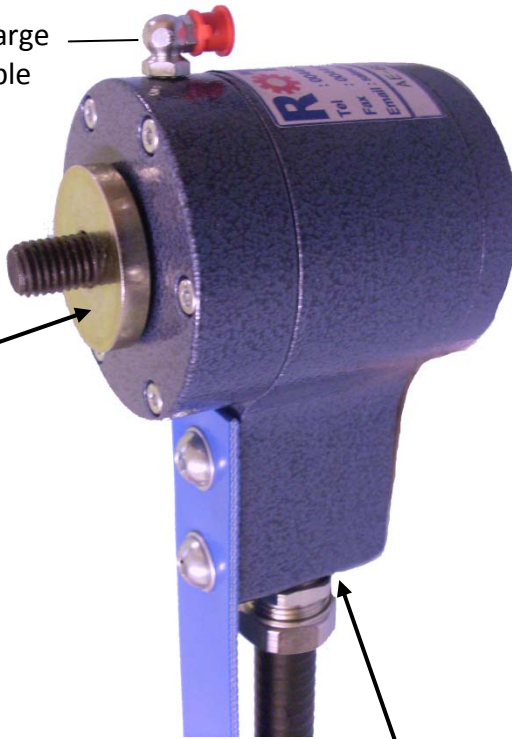

### APPLICATION EXAMPLE:

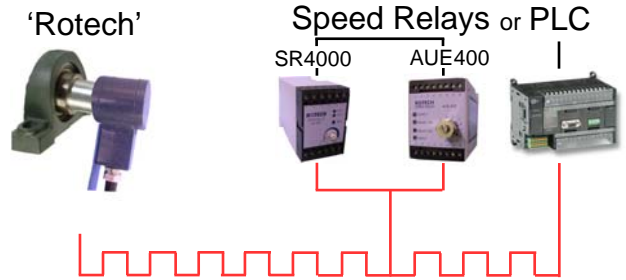

### FOR MONITORING:

- Speed
- Shaft stopped
- Distance
- Underspeed
- Direction
- Overspeed
- Belt slip
- Safety guards interlocking

### FEATURES:

- Totally self contained (no guards required)
- Maintenance free for maximum reliability
- 1 to 1000 pulses per revolution
- **Environment ingress-IP67**
- -25 to +70, 100, 125, 150 deg Celsius versions available



**NEW!**

Also available with Brad® Quick Connect/Disconnect range of receptacles



### MAG-CON

#### MAGNETIC SHAFT CONNECTOR

For Quick and Easy Installation of Rotech Shaft Mounted Sensors & Encoders.  
Simply attaches to existing shafts

**IMPORTANT NOTE:**  
MAXIMUM OPERATING SPEED IS 300RPM  
RECOMMENDED MINIMUM  
SHAFT DIAMETER FOR FITTING=35MM

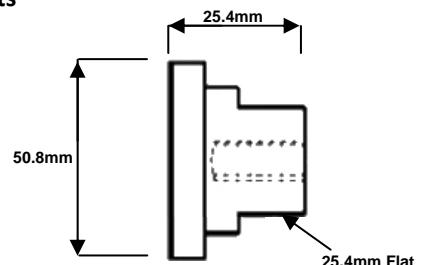
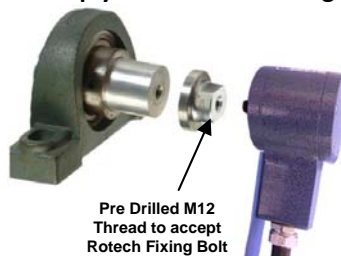

# Dimensions and Installation Information

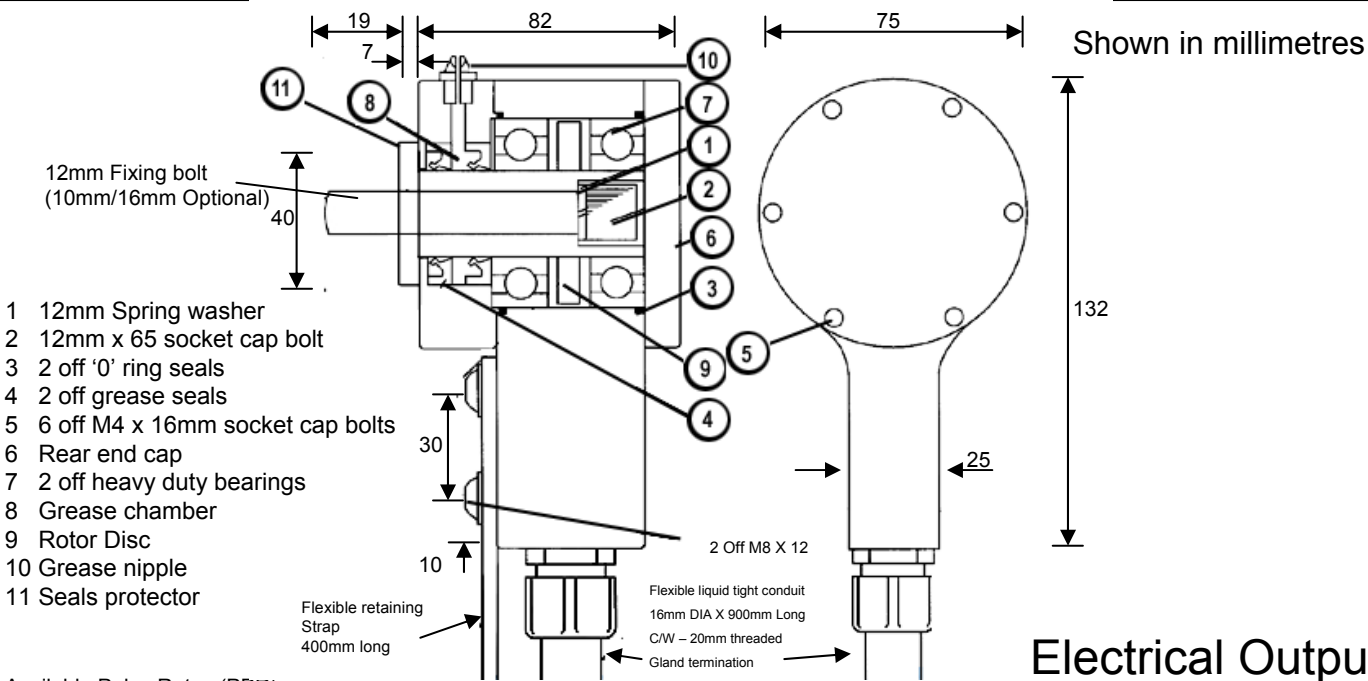

## Electrical Outputs

### Available Pulse Rates (PPR)

1,2,4,5,6,8,10,12,16,20,30,32,40,50,60,100,120,180,240,250,300,360,500,1000 (Dependent Upon Output Type)

### Type Z (2 Wire Non Polarized) 10-30Vdc

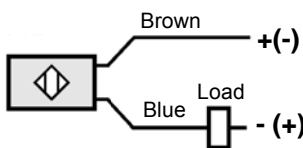

Max frequency = 1500Hz

### Type E (N.P.N) 10-30Vdc Current sink

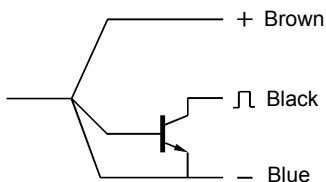

Max frequency = 600Hz

### Type E2 (P.N.P) 10-30Vdc Current source

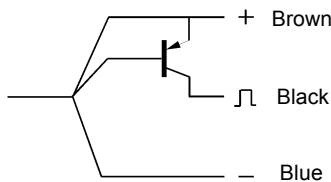

Max frequency = 600Hz

### Type E3 (N.P.N + P.N.P - 3 wire) 10-30Vdc Bi-polar - Current sink/source

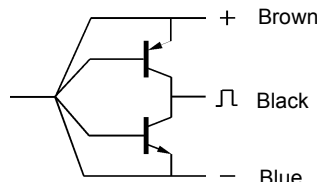

Max frequency = 1000Hz

### Type E4 (N.P.N + P.N.P - 2 Wire) 10-30Vdc Bi-polar - Current sink/source

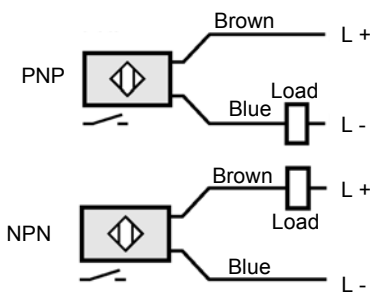

Max frequency = 1300Hz

### Type W 20-240V AC/DC 50/60Hz (1 to 30 PPR only)

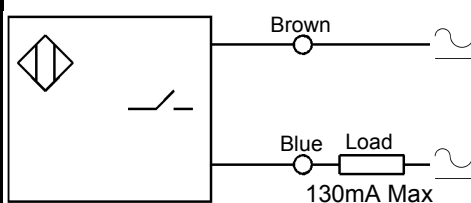

**Note**  
 Minimum operating current = 5mA

Max frequency = 25Hz (AC) 1000Hz (DC)

### Type N (Namur) 8-2 Vdc (1KΩ) Intrinsically safe circuits

The voltage and current characteristics of NAMUR sensor outputs are so low that they can be safely used in explosive environments. The power limitation is implemented in the corresponding equipment. This means that the circuit containing a NAMUR proximity sensor is only intrinsically safe if it is supplied via a corresponding isolating amplifier. Contact Rotech Systems for details of amplifiers available.

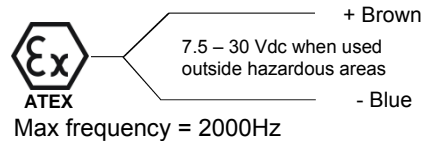

Max frequency = 2000Hz

### Type E3 Q (Quadrature) 10-30Vdc

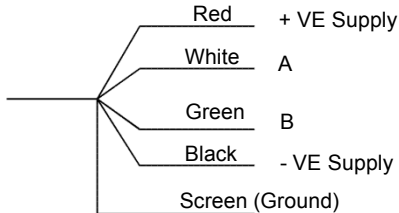

CH "A" Leads CH "B" for clockwise rotation viewed from shaft end of encoder

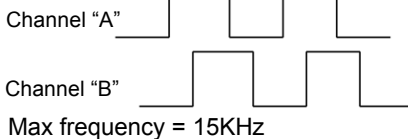

Max frequency = 15KHz

### Type E2 Q (Quadrature) 1 to 40 PPR inclusive

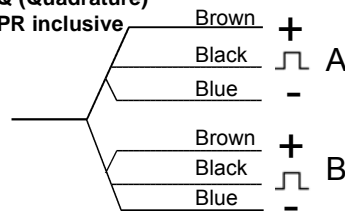

Max frequency = 600Hz